



DILE

# adapta pro

La colección AdaptaPro se compone de silla giratoria, confidente y 4 patas, permitiendo crear espacios armoniosos e integrados.

AdaptaPro es ergonomía activa: un respaldo con curvas naturales de nuestra espalda que ayuda a mantener una postura saludable.



a d a p t a p r o



a d a p t a p r o





## Silla alta sin brazos | S0000-06bb-xyy

Referencia	Base	Ruedas	Mecanismo
S1311	nylon negro	nylon/goma	contacto permanente
S1313**	aluminio pulido	nylon/goma	contacto permanente
S1310*	nylon negro	nylon/goma	sincro independiente
S1312	aluminio pulido	nylon/goma	sincro independiente

\*Para esta referencia en cualquiera de sus acabados (ver páginas de tejidos disponibles), DILE se compromete a la fabricación en un plazo máximo de **8 días**. Transcurridas las 24 horas no se admitirá modificación alguna ni anulación del pedido.

Unidades 1 / Tela cliente 78 cm / Peso 14,50 Kg / Volumen 0,17 m<sup>3</sup>

8d

color respaldo polipropileno (xx)	
01	blanco**
02	negro

\*\* Disponible sólo para la Referencia S1313



## Silla baja 4 patas sin brazos | S0000-06bb-xyy

Referencia	Base
S1321	negro

Unidades 1 / Tela cliente 78 cm / Peso 12,50 Kg / Volumen 0,25 m<sup>3</sup>

Unidades 2 / Tela cliente 156 cm / Peso 24 Kg / Volumen 0,35 m<sup>3</sup>



## Confidente patín sin brazos | S0000-06bb-xyy

Referencia	Patín
S1341	negro
S1332	chromo

Unidades 1 / Tela cliente 78 cm / Peso 24 Kg / Volumen 0,25 m<sup>3</sup>



## Confidente patín | S0000-06bb-xyy

Referencia	Patín	Brazos
S1330	gris	fijos poliuretano
S1331	chromo	fijos poliuretano

Unidades 1 / Tela cliente 78 cm / Peso 24 Kg / Volumen 0,33 m<sup>3</sup>

Unidades 2 / Tela cliente 156 cm / Peso 48 Kg / Volumen 0,35 m<sup>3</sup>



# adaptapro

## Brazos opcionales

Referencia	BR02	BR23	BR05	BR06	BR26	BR03	BR04
Características	1D	1D	1D	1D	2D	3D	4D



Asiento "PRO"  
espuma inyectada  
60kg/m<sup>3</sup>



## Accesorios

Referencia	Características
A9100	Asiento "PRO" espuma inyectada 60kg/m <sup>3</sup>
K9202*	Kit conversión taburete nylon con ruedas
K9203*	Kit conversión taburete nylon con tapones
K9210*	Kit conversión taburete aluminio con tapones
K9211*	Kit conversión taburete aluminio con ruedas

\*Incluye aro, resorte gas alto, tapones o ruedas (dependiendo Referencia seleccionada).

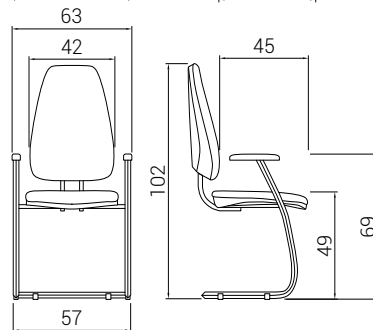
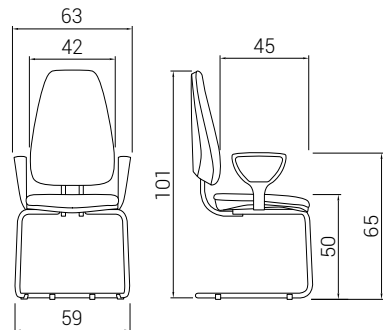
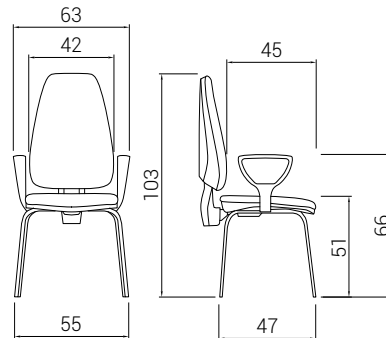
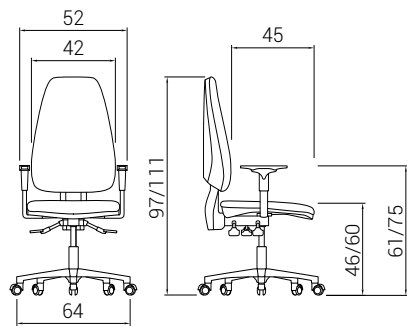

Referencia	Características
A004	Entrega silla semimontada
A006	Entrega silla montada

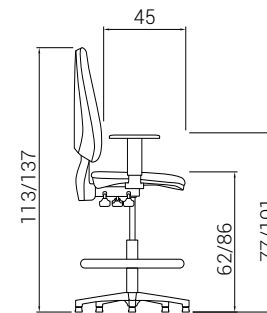

**120kg** Peso máximo

**CERTIFICADOS Y NORMATIVAS**

UNE EN 1335-1:2021, UNE EN 1335-2:2019

tapizados·materiales·acabados



## GRUPO 01 BALI



exit  
fabrics.

### Ficha Técnica

#### Composicion

100% Poliolefina

**Ancho** 140 cm/ 54 in  $\pm$  2%

#### Resistencia a la abrasión

UNE-EN 14465:2004+A1:2007 Anexo A basado en  
UNE-EN ISO 12947.2:1999/AC:2006 + 90.000 (Ciclos  
Martindale)

#### Resistencia a la rotura

UNE-EN ISO 13937-3:2001  
Urdimbre: 180 N / Trama: 160 N

#### Solidez al frote

En seco: UNE-EN ISO / 105-X122003 4/5  
En húmedo: UNE-EN ISO 105-X122003 4/5

#### Solidez de colores a la luz

UNE-EN ISO 105-B02:2001+A1:2002. Metodo 2 617  
(escala 1-8; 8 mejor valor). Apto para exterior

#### Resistencia al pilling

UNE-EN 14465:2004 - A1:2007, UNE-EN ISO 12945-  
2:2001 4/5

#### Inflamabilidad

UE: EN 1021-1:2006 (cigarro) UK:  
BS 5852:2006 (cigarro) D: DIN 66084:2003-07  
clasificaciEin P- c USA: CAL TB 117:2000 SecciOn  
E, parte 1 (CS. 191-53; CLASS 1) NFPA 260:2009  
Cover fabric CLASS 1 Autobuses: Reglamento n°  
118 de UNECE Anexo 6 (Directiva 95/28 Anexo IV)  
Condiciones ignifugas dependientes del tipo de  
espuma utilizado.

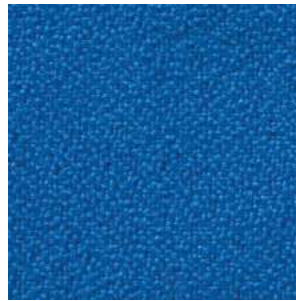

P6



P8



P20



P21

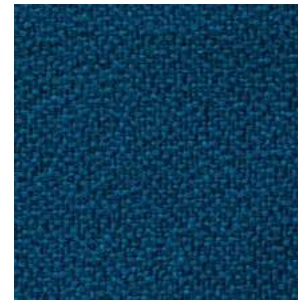

P22



P28

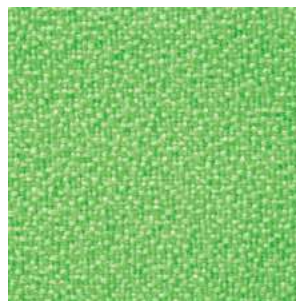

P29

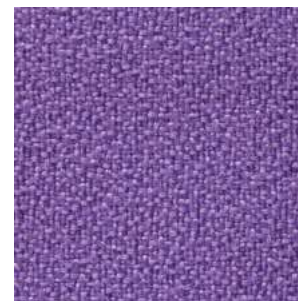

P30



Test  
de cigarrillo



No usar lejía



Puede lavarse  
en seco



Antibacterias



Ecológico



Antiestático



Reciclable  
100%



Apto  
para exterior

## GRUPO 01 POLIÉSTER



exit  
fabrics.

### Ficha Técnica

**Composición**

100% poliéster

**Ancho** 140 cm/ 54 in ± 2%

**Resistencia a la abrasión**

+ 80.000 (Ciclos Martindale) ISO 12947-2

**Resistencia a la rotura**

UNE-EN ISO 13937-3:2001

Urdimbre: 400 N / Trama: 260 N

**Solidez al frote**

En seco: UNE-EN ISO / 105-X12:2003 4/5

En húmedo: UN E-EN ISO 105-X12:2003 4/5

**Solidez de colores a la luz**

Valor: 6 (Tolerancia 5 a 8; 8 mejor valor)

ISO 105-B02 (Xenotest)

**Resistencia al pilling**

UNE-EN ISO 12945-2:2001 4/5

**Inflamabilidad**

EN 1021-1 & 2

También pasará otros estándares de inflamabilidad.

El rendimiento ignífugo depende de la espuma utilizada.

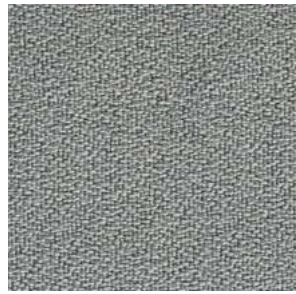

C1

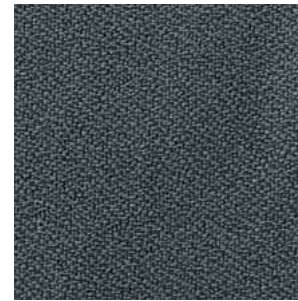

C2



C5



C7

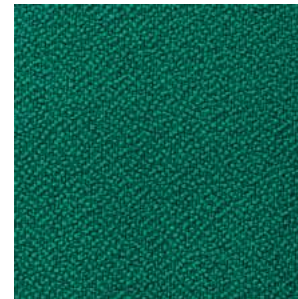

C8



C10



C14



C17



Test de cigarrillo



Test cerilla



Puede lavarse en seco



Evitar secar al sol



No usar lejía

## GRUPO 01 GOYA



exit  
fabrics.

### Ficha Técnica

**Composicion 100%**  
Polioléfina

**Ancho**  
140 cm/ 54 in ± 2%

**Resistencia a la abrasión**  
UNE-EN 14465:2004+A1:2007 Anexo A basado en  
UNE-EN ISO 12947-2:1999/AC:2006 90.000 (Ciclos  
Martindale)

**Resistencia a la rotura**  
UNE-EN ISO 13937-3:2001 Urdimbre: 130 N / Trama:  
100 N

**Solidez al frote en seco**  
UNE-EN ISO / 105-X12:2003 4/5 En húmedo: UNE-EN  
ISO 105-X12:2003 4/5

**Solidez de colores a la luz**  
UNE-EN ISO 105-B02:2001+A1:2002. Método 2 5/6  
(escala 1-8; 8 mejor valor) Apto para exterior

**Resistencia al pilling**  
UNE-EN 14465:2004 +A1:2007, UNE-EN ISO 12945-  
2:2001 4/5

**Inflamabilidad**  
UE: EN 1021-1:2006 (cigarro) UK: BS 5852:2006  
(cigarro) D: DIN 66084:2003-07 clasificación P- c USA:  
CAL TB 117:2000 Sección E, parte 1 (C.S. 191-53; CLASS  
1) NFPA 260:2009 Cover fabric CLASS 1Autobuses:  
Reglamento nº 118 de UNECE Anexo 6 (Directiva 95/28  
Anexo IV)Condiciones ignífugas dependientes del tipo  
de espuma utilizado.



D1

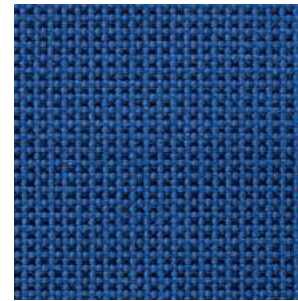

D3

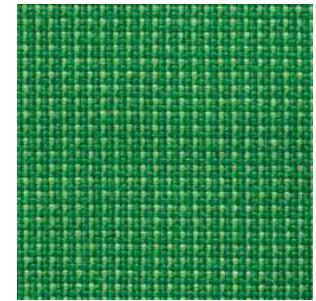

D6

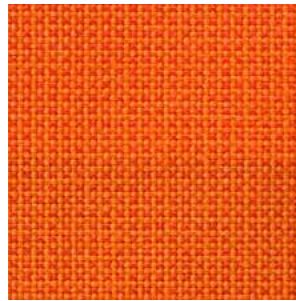

D8

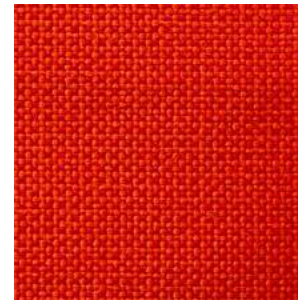

D9

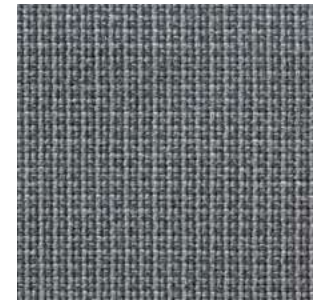

D10



D11

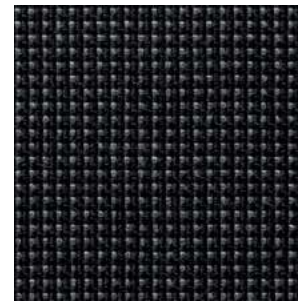

D12



Test  
de cigarrillo



No usar lejía



Puede lavarse  
en seco



Antibacterias



Ecológico



Antiestático



Reciclable  
100%



Apto  
para exterior

## GRUPO 01 TOUCH LEATHER



**¡MUY IMPORTANTE!**

No apto para instalaciones, solo uso doméstico limitado.



**¡MUY IMPORTANTE!**

Los colores claros y blanco quedan excluidos de garantía por trasvase de tejidos externos (vaqueros, ropa tintada, etc).



### Ficha Técnica

**Composición**

85 % Poliuretano (PU) - 15 % Algodón

**Ancho** 140 cm/ 54 in

**Peso** 570 g/m<sup>2</sup>

**Espesor** 1,00 - 1,10 mm.

**Resistencia a la abrasión**

50.000 (Ciclos Martindale) ISO 1247-2:1998

**Resistencia a la rotura**

Urdimbre: 3,18 kg. / Trama: 3,64 kg.

**Resistencia a la tensión**

Urdimbre: 3,18 kg. / Trama: 3,64 kg.

**Inflamabilidad**

UE: EN 1021-1:2006 (cigarro)

UK: BS 5852:2006 (cigarro)

D: DIN 66084:2003-07 clasificación P- c

USA: CAL TB 117:2000 Sección E, parte 1 (C.S. 191-53; CLASS 1)

NFPA 260:2009 Cover fabric CLASS 1

Autobuses: Reglamento nº 118 de UNECE

Anexo 6 (Directiva 95/28 Anexo IV)

Condiciones ignífugas dependientes del tipo de espuma utilizado.



R1

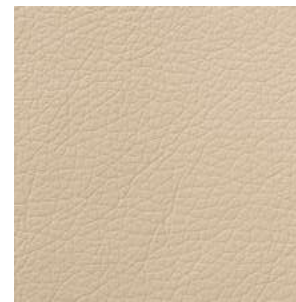

R2



R3



R4



R5



R6

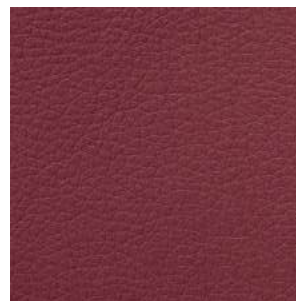

R7



R8



R9



Test de cigarrillo



Puede lavarse en seco



Lavar con paño húmedo



Evitar secar al sol



No usar lejía

## GRUPO 01 COMBI



exit  
fabrics.

### Ficha Técnica

#### Composición

100% Poliolefina

**Ancho** 140 cm/ 54 in ± 2%

#### Resistencia a la abrasión

UNE-EN 14465:2004+A1:2007 Anexo A basado en  
UNE-EN ISO 12947-2:1999/AC:2006  
+ 40.000 (Ciclos Martindale)

#### Resistencia a la rotura

UNE-EN ISO 13937-3:2001  
Urdimbre: 400 N / Trama: 260 N

#### Solidez al frote en seco

UNE-EN ISO / 105-X12:2003 4/5 En húmedo: UNE-EN  
ISO 105-X12:2003 4/5

#### Solidez de colores a la luz

UNE-EN ISO 105-B02:2001  
+A1:2002. Método 2 6/7 (escala 1-8; 8 mejor valor)  
Apto para exterior.

#### Resistencia al pilling

UNE-EN 14465:2004 +A1:2007,  
UNE-EN ISO 12945-2:2001 4/5

#### Inflamabilidad

UE: EN 1021-1:2006 (cigarro) UK:  
BS 5852:2006 (cigarro) D: DIN 66084:2003-07  
clasificación P- c USA: CAL TB 117:2000 Sección E,  
parte 1 (C.S. 191-53; CLASS 1) NFPA 260:2009 Cover  
fabric CLASS 1 Autobuses: Reglamento nº 118 de  
UNECE Anexo 6 (Directiva 95/28 Anexo IV)  
Condiciones ignifugas dependientes del tipo de  
espuma utilizado.



Test  
de cigarrillo



No usar lejía



Puede lavarse  
en seco



Antibacterias



Ecológico



Reciclable  
100%



B1

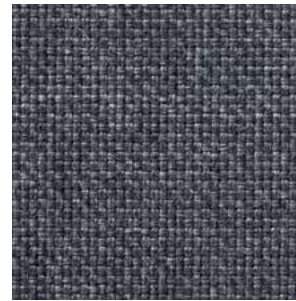

B2



B3



B4



B5

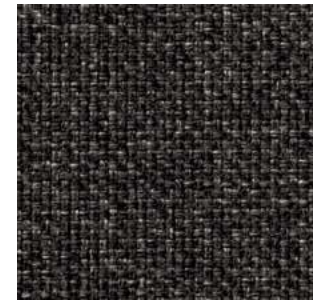

B6



B7



B8

## GRUPO 02 OCEAN



exit  
fabrics.

### Ficha Técnica

#### Composición

100% Poliéster F.R.

**Ancho** 160 cm / ± 2%

#### Resistencia a la abrasión

UNE-EN 14465:2004+A1:2007 Anexo A basado en  
UNE-EN ISO 12947-2:1999/AC:2006 + 100.000 (Ciclos  
Martindale)

#### Resistencia a la rotura

UNE-EN ISO 13937-3:2001  
Urdimbre: 68 N / Trama: 73 N

#### Solidez al frote

En seco: UNE-EN ISO 105-X12:2003 4/5  
En húmedo: UNE-EN ISO 105-X12:2003 4/5

#### Solidez de colores a la luz

UNE-EN ISO 105-B02:2001+A1:2002. Método 2 4/5  
(escala 1-8; 8 mejor valor)

#### Resistencia al pilling

UNE-EN 14465:2004 +A1:2007, UNE-EN ISO 12945-  
2:2001 4/5

#### Inflamabilidad

UE: EN 1021-1:2006 (cigarro)  
UK: BS 5852:2006 (cigarro)  
D: DIN 66084:2003-07 clasificación P- c  
USA: CAL TB 117:2000 Sección E, parte 1(C.S. 191-53;  
CLASS 1)  
NFPA 260:2009 Cover fabric CLASS 1  
Autobuses: Reglamento nº 118 de UNECE Anexo 6  
(Directiva 95/28 Anexo IV)  
Condiciones ignífugas dependientes del  
tipo de espuma utilizado.



Test  
de cigarrillo



Test cerilla



Puede lavarse  
en seco



Evitar secar  
al sol



No usar lejía

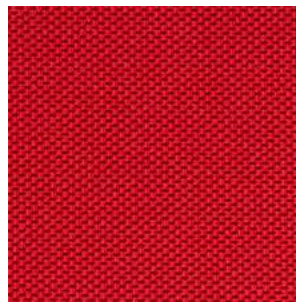

G2

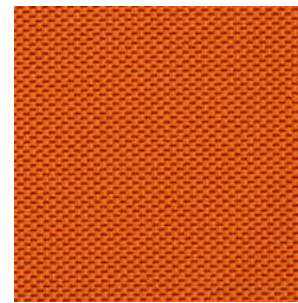

G3

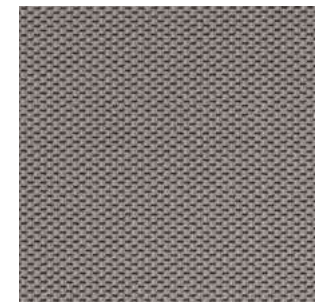

G4

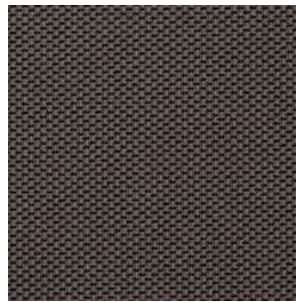

G5

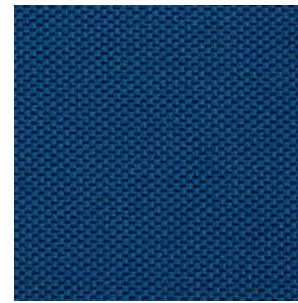

G7

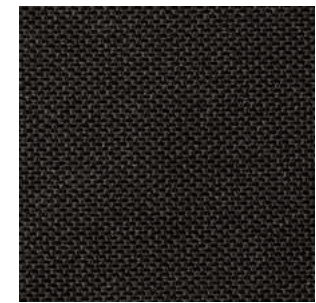

G8

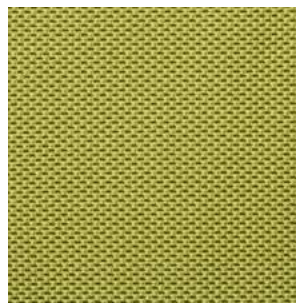

G10

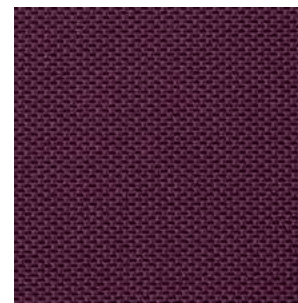

G12

## GRUPO 02 ELASTIKA FR



exit  
fabrics.

### Ficha Técnica

#### Composición

100% Poliéster F.R.

Ancho 140 cm/ 54 in ±

#### Resistencia a la abrasión

UNE-EN 14465:2004+A1:2007 Anexo A basado en  
UNE-EN ISO 12947-2:1999/AC:2006  
+ 100.000 (Ciclos Martindale)

#### Resistencia a la rotura

UNE-EN ISO 13937-3:2001  
Urdimbre: 81 N / Trama: 66 N

#### Solidez al frote en seco

UNE-EN ISO / 105-X12:2003  
4 En húmedo: UNE-EN ISO 105-X12:2003 4

#### Solidez de colores a la luz

UNE-EN ISO 105-B02:2001  
+A1:2002. Método 2 5/6 (escala 1-8; 8 mejor valor)

#### Resistencia al pilling

UNE-EN 14465:2004 +A1:2007, UNE-EN ISO 12945-  
2:2001 4/5

#### Inflamabilidad

UE: EN 1021-1:2006 (cigarro) EN  
1021-2:2006 (cerilla) ; UK: BS 5852:2006 (cigarro  
y cerilla); BS 5852:2006 Crib 5; BS 7176:2007  
Medium Hazard; F: NF P92-507:2004 clasificación  
M.1 NF D 60-013:2006 (AM 18) ; D: DIN 4102-1:1998  
clasificación B2; DIN 66084:2003 clasificación  
P-a; ES: UNE 23727-90 1R clasificación M.1; I: UNI  
9175:2010 Clase 1.IM; USA: CAL TB 117:2000 Sección  
E, parte 1(C.S. 191-53; CLASS 1); NFPA 260:2009  
Cover fabric CLASS 1; Autobuses: Reglamento nº  
118 de UNECE Anexo 6; Marítimo: IMO MSC.307  
(88) Anexo I Parte 8 ; Aeronáutico: FAR 25.853 a)  
Apéndice F Part I Parágrafo (a)(1)(ii). Condiciones  
ignífugas dependen del tipo de espuma utilizado.



Test  
de cigarrillo



Test cerilla



Puede lavarse  
en seco



Evitar secar  
al sol



No usar lejía



12

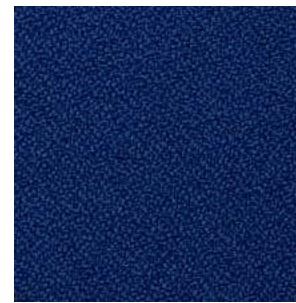

13

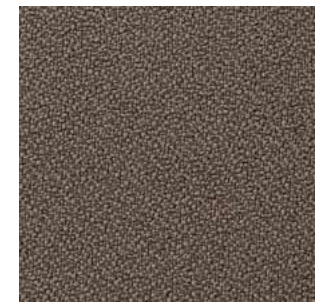

14

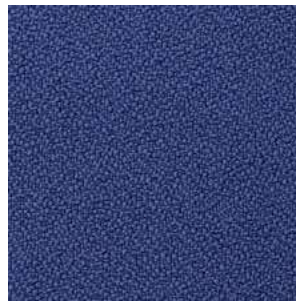

17

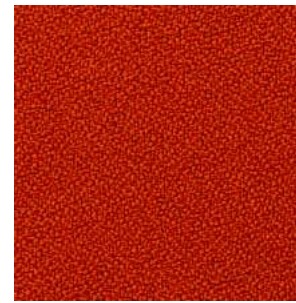

110

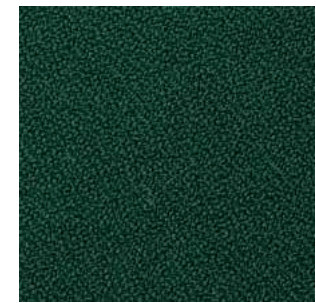

111

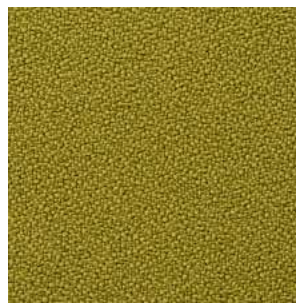

112



114

## GRUPO 02 ORUGA



FROCA

### Ficha Técnica

**Composición**

100 % poliéster

**Ancho** 150 cm

**Resistencia de las costuras**

Urdimbre: 1.8 mm / BS 3320:1988

Trama: 2 mm / BS 2543:1995

**Resistencia a la abrasión**

+70.000 (Ciclos Martindale)

**Resistencia a la rotura**

Urdimbre: 64 N / ISO13937-3:2000

Trama: 64 N / ISO13937-3:2000

**Resistencia de rotura al rasgado**

Urdimbre: 140,36 N / EN ISO 13937-3

Trama: 92,62 N / EN ISO 13937-3

**Solidez de colores a la luz**

4 / ISO 105 B02:1994

**Solidez a la limpieza en seco**

4-5 / ISO 105X12:2001

**Solidez de los colores al lavado**

4 / ISO 105X12:2001

**Resistencia al pilling**

4-5 / ISO 12945-2



02



04

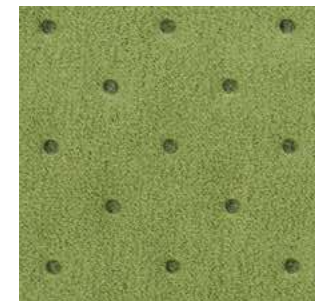

09

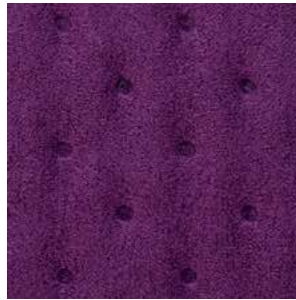

010



011



012



015



Puede lavarse  
en seco



Acabados  
antimanchas



Evitar secar  
al sol



No usar lejía



## GRUPO 02 NILO



### ¡MUY IMPORTANTE!



Los colores claros y blanco quedan excluidos de garantía por trasvase de tejidos externos (vaqueros, ropa tintada, etc).

FROCA

### Ficha Técnica

#### Composición

Superficie: 100 % poliuretano  
Interior: 70% poliéster / 30 % algodón

Ancho 140 cm / 54 in +/- 2cm

#### Resistencia a la abrasión

+100.000 (Ciclos Martindale)

#### Resistencia a la rotura

Urdimbre: 54,6 N / A EN ISO 13937-3  
Trama: 46,7 N / A EN ISO 13937-3

#### Resistencia de rotura al rasgado

Urdimbre: 54,6 N / A EN ISO 13937-3  
Trama: 46,7 N / A EN ISO 13937-3

#### Solidez de colores a la luz

> 5 / A EN ISO 105-B 02

#### Solidez a la limpieza en seco

5: A EN ISO 105-X12

#### Solidez de los colores al lavado

5: A EN ISO 105-X12

#### Resistencia al pilling

ISO/DIS 12945-2

#### Tratamiento Azo

No se detectan

#### Anti hidrólisis

jungle test 3 años

#### Inflamabilidad

EN 1021-1 & 2

También pasará otros estándares de inflamabilidad. El rendimiento ignífugo depende de la espuma utilizada.



Test de cigarrillo



Test cerilla



Puede lavarse en seco



Evitar secar al sol



No usar lejía



Anti hidrólisis



Ecológico



Antialérgico



Sin productos químicos



NL1



NL7



NL9



NL12



NL15



NL33



NL39



NL43

## GRUPO 02 MADISON



FROCA

### Ficha Técnica

**Composición**

80 % pes. / 20 % cot.

**Ancho** 140 cm/ 54 in

**Resistencia de las costuras**

Urdimbre: 1.8 mm / BS 3320:1988

Trama: 2 mm / BS 2543:1995

**Resistencia a la abrasión**

+ 30.000 (Ciclos Martindale)

**Resistencia a la rotura**

Urdimbre: 729,0 n/18,1% Cat. A en ISO 13934-1

Trama: 687,0 n/29,9% Cat. A en ISO 13934-1

**Resistencia de rotura al rasgado**

Urdimbre: 140,36 N / EN ISO 13937-3

Trama: 92,62 N / EN ISO 13937-3

**Solidez de colores a la luz**

>5 / UNE 40187 / BS 1006-B02

**Solidez a la limpieza en seco**

5: ISO 105-D01 / UNE 40099

**Solidez de los colores al lavado**

5: ISO 105-C06 / UNE 40029

**Resistencia al pilling**

ISO/DIS 12945-2



MA1



MA3

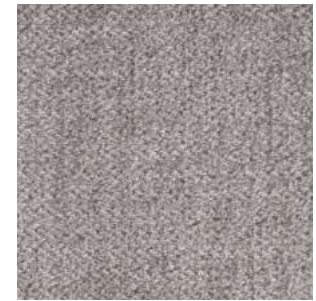

MA4



MA6



MA12

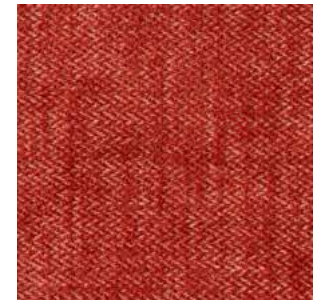

MA17



MA19



MA20



Lavar con paño  
húmedo



Evitar secar  
al sol



No usar lejía

## GRUPO 02 TONAL



Gabriel®

### Ficha Técnica

**Composición**

100% Poliéster reciclado

**Ancho** 140 cm/ 55 in

**Peso** 315 g/m<sup>2</sup>

**Resistencia a la abrasión**

+ 100.000 (Ciclos Martindale) ISO 12947-2/14465  
Resistencia a la abrasión wyzenbeek (ASTM D4157-07) (uso severo) +100.000 (Ciclos Martindale)

**Resistencia al pilling**

UNE-EN ISO 12945-2:2001 4/5

**Solidez de colores a la luz**

UNE-EN ISO 105-B02.

Escala 1-8; 6-8

**Solidez al frote en seco**

Seco: UNE-EN ISO / 105-X122003 4/5

En húmedo: UNE-EN ISO 105-X122003 4/5

**Prueba acústica resistencia al flujo de aire**

EN 29053 & ISO 9053-1

**Solidez de colores a la luz**

UNE-EN ISO 105-B02 método 2

**Solidez del color a la transpiración**

AATCC 15. Escala 1-5; 5 ; BS EN ISO 105-E04

**Deslizamiento de las costuras**

ASTM D4034 (Deslizamiento de hilo en una costura cosida); BS EN ISO 13936-2

**Solidez a la limpieza en seco**

BS EN ISO 6330 4M 40 C PC

**Inflamabilidad**

UE: EN 1021-1:2006 (cigarro) EN 1021-2:2006 (cerilla); UK: BS 5852:2006 (cigarro y cerilla); BS 5852:2006 Crib 5; BS 7176:2007 Medium Hazard; DIN 4102-1:1998 clasificación B1; NF P92-503:2004 clasificación M.3; Class Uno UNI 8456 UNI 9174; CA TB 117-2013



Test de cigarrillo



Test cerilla



Puede lavarse en seco



Evitar secar al sol



No usar lejía

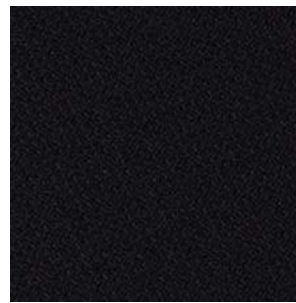

T01

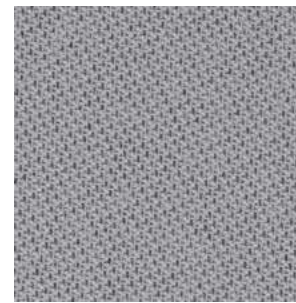

T02

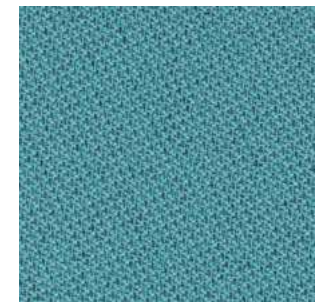

T03



T04

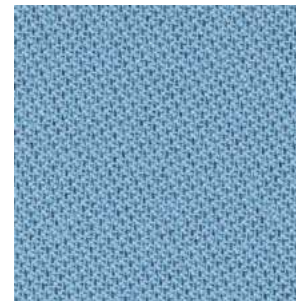

T05



T06

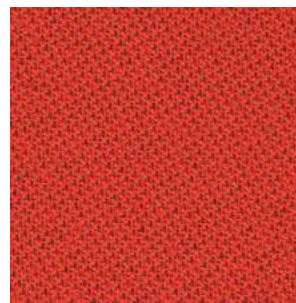

T07

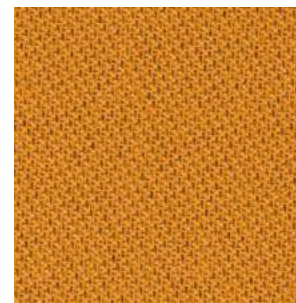

T08

**GRUPO 02**  
**ONE**



**FIDIVI\***

**Ficha Técnica**

**Composición**

100% Poliéster reciclado

**Ancho** 150 cm/ 59 in

**Resistencia a la abrasión**

+ 100.000 (Ciclos Martindale) ISO 12947-2

**Solidez de colores a la luz**

>6 / ISO 105-B02 (Xenotest)

**Solidez al frote**

En seco: UNE-EN ISO / 105-X122003 4/5

En húmedo: UNE-EN ISO 105-X122003 4/5

**Resistencia al pilling**

ISO 12945-2; Escala 1-5; 5

**Inflamabilidad**

UE: EN 1021-1:2006 (cigarro) EN 1021-2:2006 (cerilla)

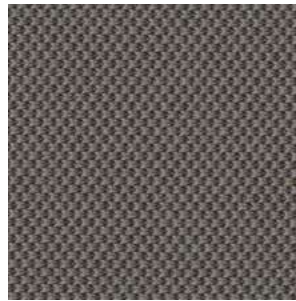

ON1

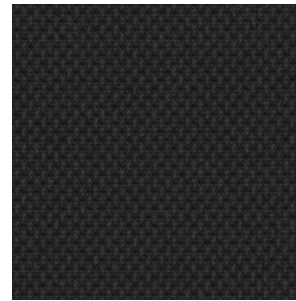

ON2

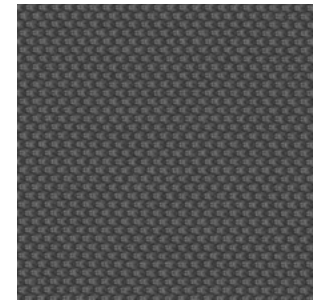

ON3

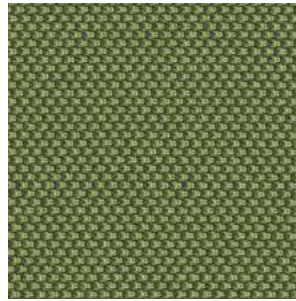

ON4

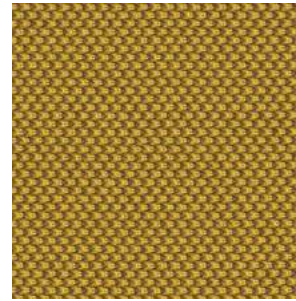

ON5



ON6

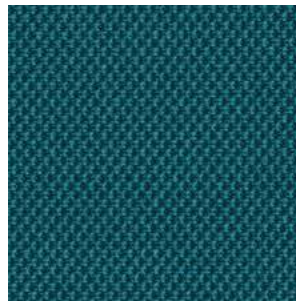

ON7



ON8

## GRUPO 03 VALENCIA



### ¡MUY IMPORTANTE!



Los colores claros y blanco quedan excluidos de garantía por trasvase de tejidos externos (vaqueros, ropa tintada, etc).

SPRADLING®

### Ficha Técnica

#### Composición

100% poliéster

Ancho 137 cm - ISO 2286-1

#### Resistencia a la abrasión

+ 300.000 (Martindale ciclos) ISO 12947-2

#### Resistencia a la rotura

ISO 4674-1 MB NEWTON (MIN.)

Urdimbre: 29 N / Trama: 25 N

#### Solidez al frote

En seco: UNE-EN ISO / 105-X12:2003 4/5

En húmedo: UNE-EN ISO 105-X12:2003 5

#### Solidez de colores a la luz

DIN 54004 / NTC 1479 Lana Azul

Cal≥7 1,000 Hours

#### Resistencia a la tensión

ISO 1421 M1 NEWTON / MIN

Urdimbre: 405 N / Trama: 198

#### Inflamabilidad

FMVSS 302, IMO Res. MSC.307(88) - (2010 FTP Code) Annex 1 Part 8; FAR 25.853 (A) Appendix F Part. I(a)(1)(ii);

UNE 23.727 90: M2; EN 1021 PARTE 1 & 2;

DIN 4102 (B2); ÖNORM B 3825; ÖNORM B 3800 Teil 1; CALIFORNIA T.B. 117-2013; UFAC Fabric - Class I;

NFP 92.503: M2; EN 71-2; UNI 9175: 1.IM;ECE R118



Test de cigarrillo



Test cerilla



Puede lavarse en seco



Evitar secar al sol



No usar lejía



Impermeable



Antiestático



Antibacterias



Antialérgico



Sin productos químicos



VA5



VA6



VA11



VA14



VA15



VA16



VA21



VA22

## GRUPO 03 DEKORA



exit  
fabrics.

### Ficha Técnica

#### Composición

100% Poliolefina

**Ancho** 140 cm/ 54 in ± 2%

#### Resistencia a la abrasión

UNE-EN 14465:2004+A1:2007 Anexo A basado en  
UNE-EN ISO 12947-2:1999/AC:2006  
+ 40.000 (Ciclos Martindale)

#### Resistencia a la rotura

UNE-EN ISO 13937-3:2001  
Urdimbre: 120 N / Trama: 130 N

#### Solidez al frote

En seco: UNE-EN ISO / 105-X12:2003 4/5  
En húmedo: UNE-EN ISO 105-X12:2003 4/5

#### Solidez de colores a la luz

UNE-EN ISO 105-B02:2001 +A1:2002.  
Método 2 5/6 (escala 1-8; 8 mejor valor)  
Apto para exterior

#### Resistencia al pilling

UNE-EN 14465:2004 +A1:2007,  
UNE-EN ISO 12945-2:2001 4/5

#### Inflamabilidad

UE: EN 1021-1:2006 (cigarro)  
UK: BS 5852:2006 (cigarro)  
D: DIN 66084:2003-07 clasificación P- c  
USA: CAL TB 117:2013 Sección 1: COVER FABRIC TEST  
NFPA 260:2013 CLASS 1  
Autobuses: Reglamento nº 118 de UNECE Anexo 6  
(Directiva 95/28 Anexo IV)  
Condiciones ignífugas dependientes del tipo de  
espuma utilizado.



Test  
de cigarrillo



Puede lavarse  
en seco



No usar lejía



Evitar secar  
al sol



Ecológico



Antiestático



Reciclable  
100%

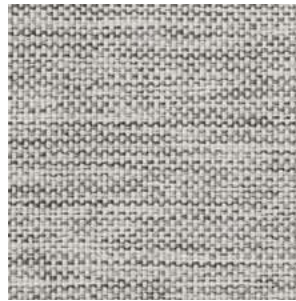

DE1



DE2



DE3



DE4



DE5

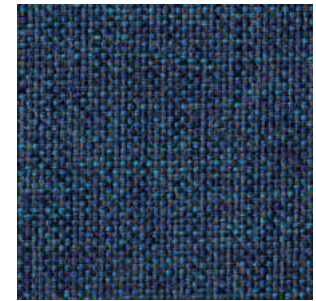

DE6



DE7

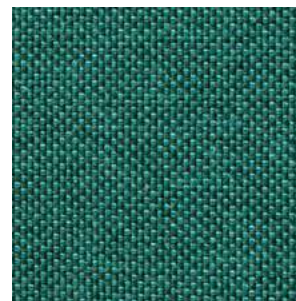

DE8

## GRUPO 03 FELICITY



Gabriel

### Ficha Técnica

#### Composición

100% Poliéster reciclado

**Ancho** 140 cm/ 55 in

**Peso** 430 g/m<sup>2</sup>

#### Resistencia a la abrasión

+ 90.000 (Ciclos Martindale) ISO 12947-2/14465

Resistencia a la abrasión wyzenbeek (ASTM D4157-07) (uso severo) +100.000 (Ciclos Martindale)

#### Resistencia al piling

UNE-EN ISO 12945-2:2001

Escala 1-5; 5

#### Solidez de colores a la luz

UNE-EN ISO 105-B02.

Escala 1-8; 5-7

#### Solidez al frote en seco

En seco: UNE-EN ISO / 105-X122003 4/5

En húmedo: UNE-EN ISO 105-X122003 4/5

#### Prueba acústica resistencia al flujo de aire

EN 29053 & ISO 9053-1d

#### Solidez de colores a la luz

UNE-EN ISO 105-B02 método 2

#### Solidez del color a la transpiración

AATCC 15. Escala 1-5; 5 ; BS EN ISO 105-E04

#### Deslizamiento de las costuras

ASTM D4034 (Deslizamiento de hilo en una costura cosida); BS EN ISO 13936-2

#### Solidez a la limpieza en seco

BS EN ISO 6330 4M 40 C PC

#### Inflamabilidad

UE: EN 1021-1:2006 (cigarro) EN 1021-2:2006

(cerilla); UK: BS 5852:2006 (cigarro y cerilla); BS

5852:2006 Crib 5; BS 7176:2007 Medium Hazard;

DIN 4102-1:1998 clasificación B1; NF P92-503:2004

clasificación M.3; Class Uno UNI 8456 UNI 9174; CA

TB 117-2013



Test  
de cigarrillo



Test cerilla



Puede lavarse  
en seco



Evitar secar  
al sol



No usar lejía



FE1



FE2



FE3



FE4



FE5

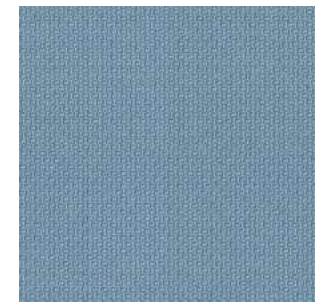

FE6



FE7

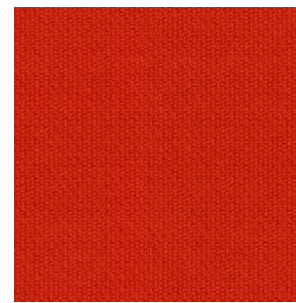

FE8

## GRUPO 04 PIEL



### ¡MUY IMPORTANTE!

Los colores claros y blanco quedan excluidos de garantía por trasvase de tejidos externos (vaqueros, ropa tintada, etc).

### Ficha Técnica

**Composición**

100% Piel Bovina

**Curtición al cromo**

Tintada Pasante

**Acabado Pigmentado**

**Grabado Madras**

**Talla media**

ca. 4 m2. Aprox.

**Espesor medio**

ca. 0.9 - 1 mm.

**Flexometría**

20.000 iuf/20

**Solidez al frote**

En seco: 500 iuf 450

En húmedo: 100 iuf 450

Valor pH min. 3,5 din 53312



Lavar con paño húmedo



Evitar secar al sol



No usar lejía



Libre de CFC



Libre de pentaclorofenol



F1

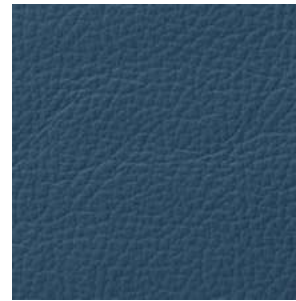

F2



F3



F6



F8

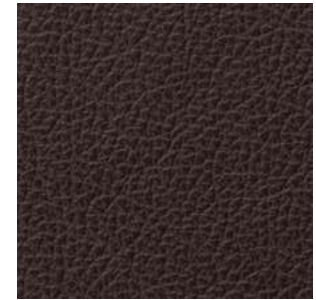

F14



F18

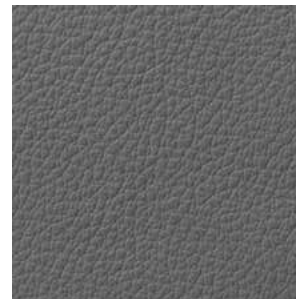

F20





dileoffice.com